

These vacuum generators share the same technical features as the others of the M series described above. Their distinctive feature is their silent operation.

In fact, along with the built-in silencer, they also have an external SSX silencer for a further noise reduction.

These generators are particularly recommended in work environments where the noise level must be kept within very low values.

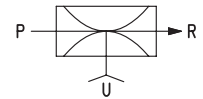
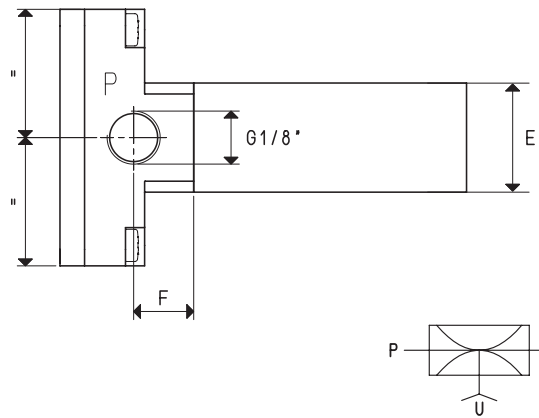
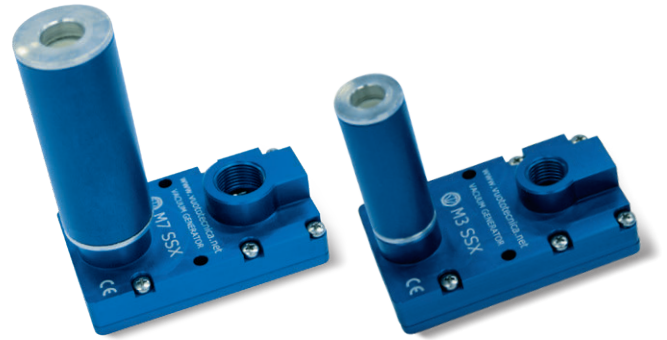
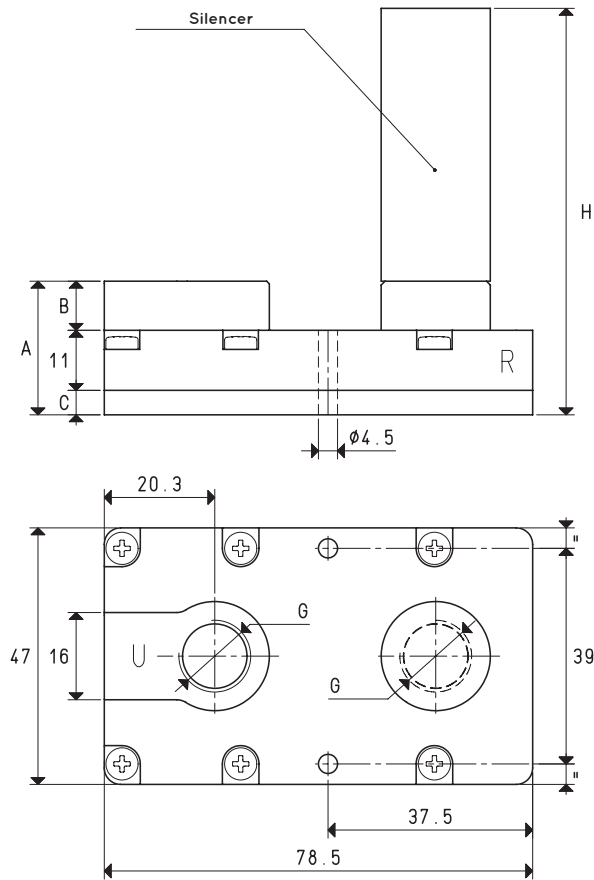

P=COMPRESSED AIR CONNECTION R=EXHAUST U=VACUUM CONNECTION

Item		M 3 SSX			M 7 SSX		
Intake air flow rate	m ³ /h	3.0	3.4	3.6	5.4	5.8	6.2
Maximum level of vacuum	-KPa	62	82	85	62	82	85
Final pressure	mbar abs.	380	180	150	380	180	150
Supply pressure	bar	3	4	5	3	4	5
Optimal supply pressure	bar			5			5
Air consumption	NI/s	0.5	0.7	0.8	0.8	1.2	1.4
Operating temperature	°C			-10 / +80			-10 / +80
Noise level at optimal supply pressure	dB(A)			52			58
Weight	g			109			111
A				24.5			25.5
B				9			10
C				4.5			4.5
E	∅			20			29
F				11			12
G	∅			G1/4"			G3/8"
H				74.5			97.5
Spare parts		M 3 SSX			M 7 SSX		
Silencer	item	SSX 1/4"			SSX 3/8"		
Exhaust silencer	item	00 15 150			00 15 150		
Sealing kit and reed valves	item	00 KIT M 3			00 KIT M 7		

Note: All vacuum values indicated in the table are valid at the normal atmospheric pressure of 1013 mbar and obtained with a constant supply pressure.

Vacuum generator supply must be carried out with non-lubricated compressed air, 5 micron filtration, in accordance with standard ISO 8573-1 class 4.

Air flow rate (NI/s) at different level of vacuum (-KPa) at optimal supply pressure

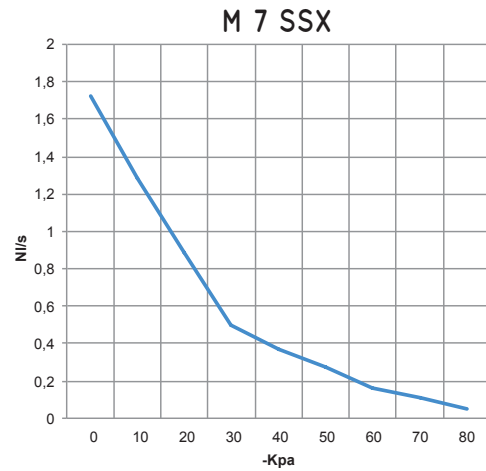
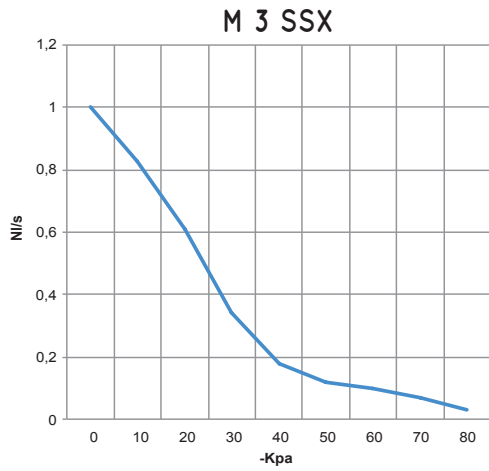

Generator item	Supp. press. bar	Air consumption NI/s	Air flow rate (NI/s) at different levels of vacuums (-KPa) at optimal supply pressure										Max vacuum -KPa
			0	10	20	30	40	50	60	70	80		
M 3 SSX	5.0	0.8	1.00	0.83	0.61	0.34	0.18	0.12	0.10	0.07	0.03	85	
M 7 SSX	5.0	1.4	1.72	1.28	0.89	0.50	0.37	0.27	0.16	0.11	0.05	85	

Evacuation rates (ms/l = s/m³) at different levels of vacuums (-KPa) at optimal supply pressure

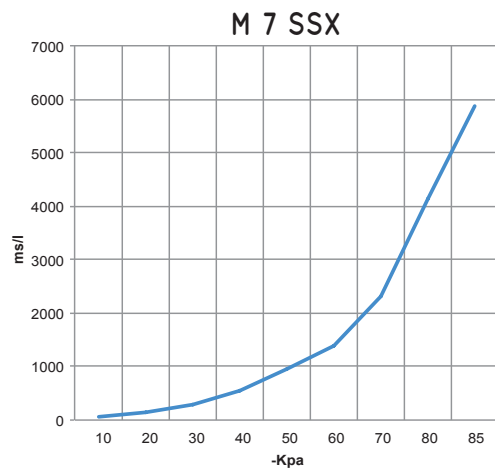
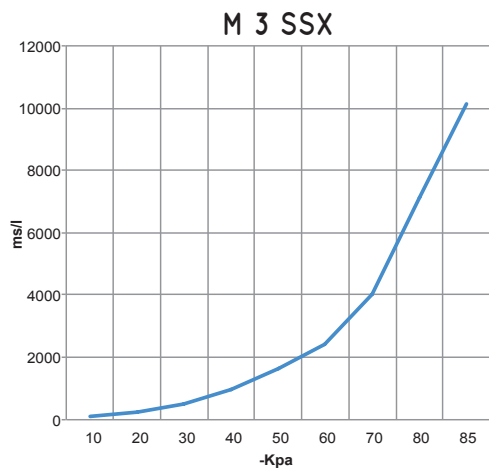

Generator item	Supp. press. bar	Air consumption NI/s	Evacuation rates (ms/l = s/m³) at different levels of vacuums (-KPa) at optimal supply pressure										Max vacuum -KPa
			10	20	30	40	50	60	70	80	85		
M 3 SSX	5.0	0.8	106	244	491	969	1642	2398	4004	7128	10122	85	
M 7 SSX	5.0	1.4	61	142	285	563	954	1394	2328	4144	5885	85	